



Electric locks and gate closer



MADE IN
ITALY

MADE IN
ITALY



Electric locks for doors and gates: Italian development, design and production process.

The CISA range of electric locks for gates and entrance doors offers a series of products that are best sellers due to their quality, design and efficiency.

Today they come in a new guise, offering more innovative, corrosion-resistant and aesthetically pleasing solutions.

The supply chain is fully controlled: from research and development to production and assembly. CISA's products are tested by our **ACCREDIA** -accredited test laboratory, which certifies their conformity with the highest requirements of the European standards to guarantee **Made in Italy** excellence.

The Faenza and Monsampolo plants apply organisational best practices, state-of-the-art technologies and a highly specialised workforce. CISA is compliant with the **ISO 9001:2015** standard on the Quality Management Systems.



FAENZA (RA)

CISA S.p.A. | Central Headquarters
Administrative headquarters, offices
and R&D

CISA S.p.A. | Site 2
Production



MONSAMPOLO DEL TRONTO (AP)

CISA S.p.A.
Offices and production



Electric locks and gate closer.

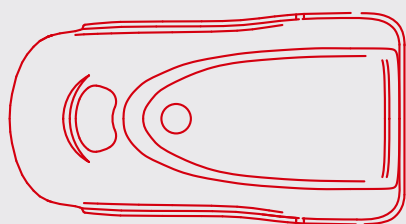

CISA ELETRIKA

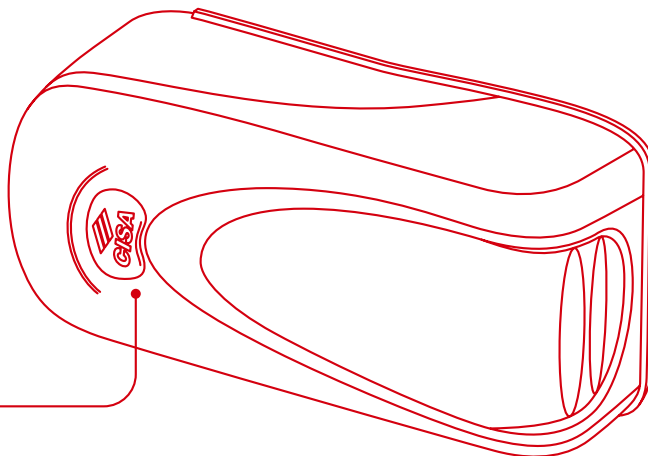

**ELECTRIC LOCKS
SERIES 11000**

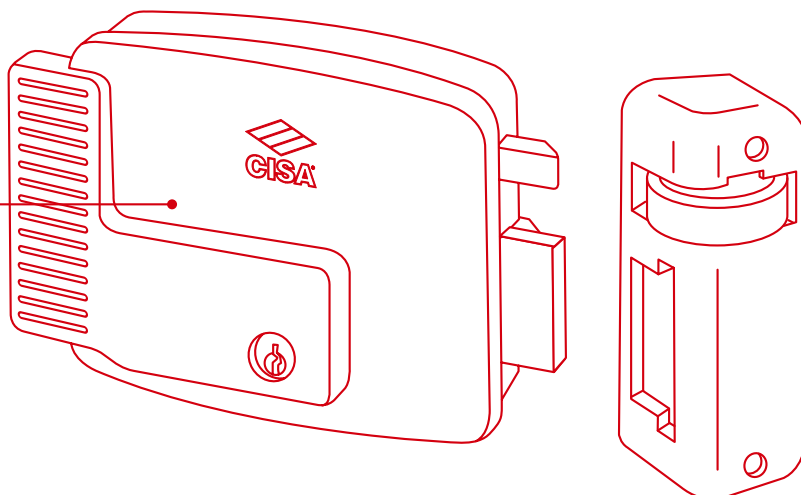

CISA GATE CLOSER

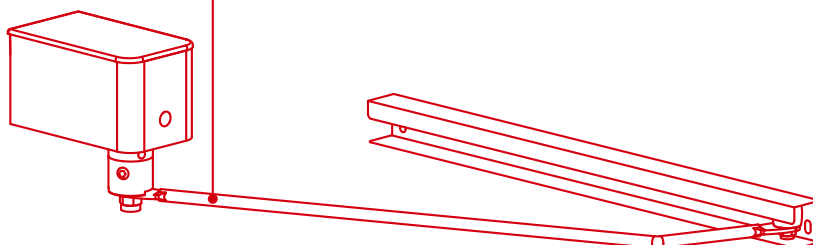

CISA Elettrika

Elettrika, the electrically operated lock by CISA, is the ideal solution for controlling the opening and closing cycle of all types of doors and gates, guaranteeing high resistance to forced entry.

MAIN FEATURES AND BENEFITS:

- Rotary hook deadbolt for increased resistance to forced entry.
- Self-adjustable striker ensuring perfect closure over time.
- Steel casing to protect the lock.
- Electric release system for increased resistance to vibrations and impact strength.

 Watch the video



MADE IN
ITALY

CISA Elettrika

The elegant and efficient solution for safer living in your home.

COMFORT & DESIGN

- Elettrika's reloading system ensures silent opening and closing operation as it does not require a strong latch action as with traditional locks.
- The rotary hook deadbolt reduces the rebound of the gate during violent closing, typical of all standard electrically operated locks.



PATENTED SECURITY AND RELIABILITY

- Rotary hook dead-bolt for a pull resistance of up to 2,000 Kg: up to six times that of standard locks.
- Steel protection casing to prevent access to the lock's internal components, electrical connection and fixing screws, when the gate is closed.
- Elettrika guarantees constancy of operation for more than 1,000,000 opening cycles. European standards EN 12209 require 200,000 opening/closing cycles in order to issue certification.

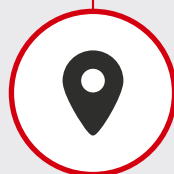
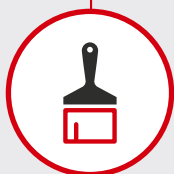

HIGH RESISTANCE TO CORROSION

Special epoxy powder coating guarantees high resistance against weathering in the event of outdoor installations or in very corrosive environments (e.g. maritime areas).

MADE IN ITALY

Product compliant with the highest requirements of European standards to guarantee Made in Italy excellence.

CERTIFIED PRODUCT

The new electric lock boasts a grade 6 Security of the European standard EN 14846.

Maximum flexibility

Wide range of applications and interchangeability

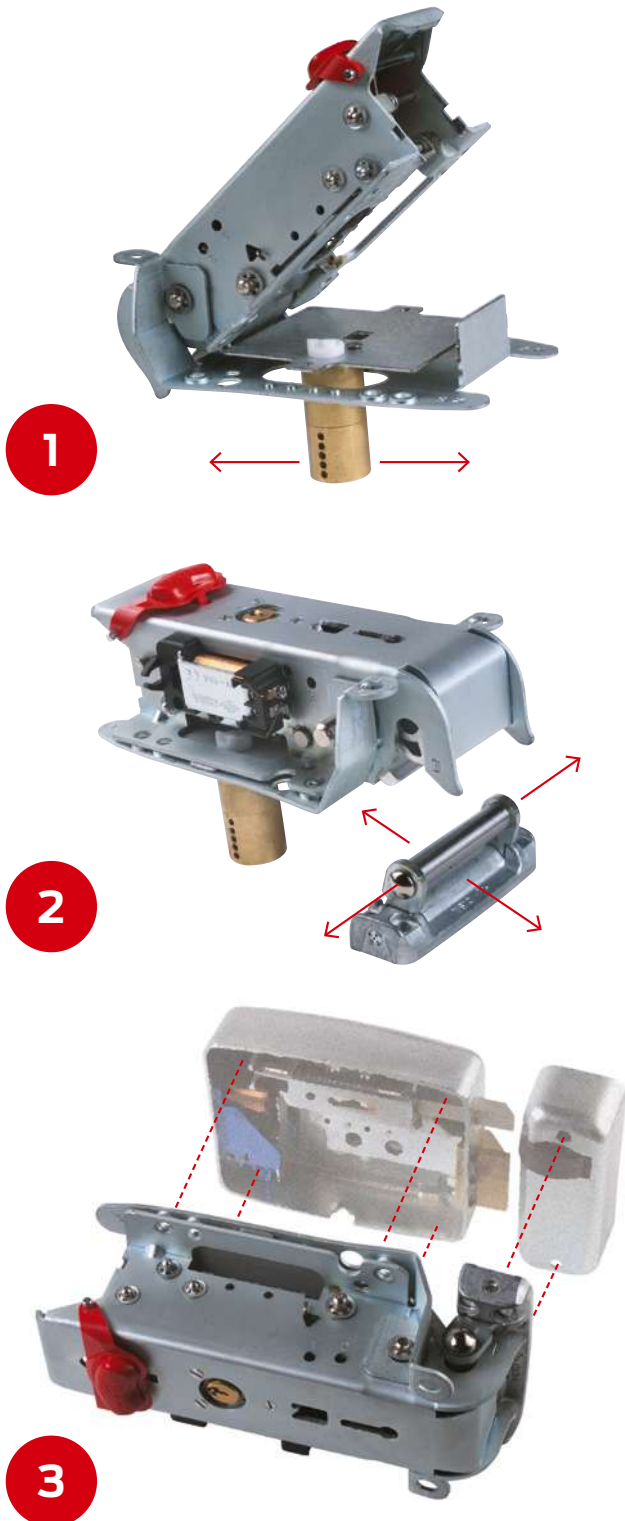

Elettrika can be installed on all types of doors and gates with maximum flexibility:

- non handed: it can be easily adapted to suit either right or left opening doors (**fig. 1**), with just one simple operation (patented system)
- it is quickly and easily variable with regard to backset: from 50 to 80 mm (**fig. 1**), (patented system)
- It is equipped with a self-adjusting striker (**fig. 2**) active both vertically (gate uprights) and horizontally (variable distance between gate leaf and gate frame) (patented system).

The rotary hook dead-bolt of Elettrika can be operated in two different modes (patented system):

- automatic opening: the door is opened by the deadbolt rotation
- ready to open: the deadbolt is released but the door remains closed; you must push to open it. The operation mode is selected by acting directly on the lock

Elettrika is interchangeable with all types of electrically operated locks found on the market (**fig. 3**).

Interchangeability is possible due to the position of the screw holes, which match those of other electrically operated locks (see dotted red lines).



Elettrika

The range



TECHNICAL FEATURES

- Protective steel casing
- Rotary hook deadbolt in extruded aluminium
- Metal striker with stainless steel "swinging pin"
- Coated internal components
- Power supply: 12 V AC CE
- Absorbed current: 3A
- High resistance to corrosion (240 hours in salt spray)

OPERATION

- From outside with the key
- From inside with a push-button or a key plus electric control

SUPPLIED AS STANDARD

- Striker
- Single or double cylinder
- Fixing screws
- Fixing plates (if required)
- 2 spacers for striker
- Instruction sheet
- 3 keys item 1.01070.10.1

HAND

- Non-handed

FINISHES

- Epoxy powder coating in anthracite grey
- Zinc-coating fin. 79

STANDARDS

- Certified to EN 14846:08 Grade 6 Security (2,000 kg lateral thrust)

ACCESSORIES AVAILABLE ON REQUEST

- BOOSTER PLUS module item 1.07022.10.0
- BOOSTER module item 1.07022.00.0
- COIL module for BTicino systems item 1.07025.10.0
- MICRO-SWITCH module item 1.07023.00.0
- Protective casing for external cylinder item 1.07056.00.0
- Spacers for striker without lip item 1.07021.01
- Spacers for long lipped striker item 1.07021.11.0
- Indicator light kit item 1.07126.01.0

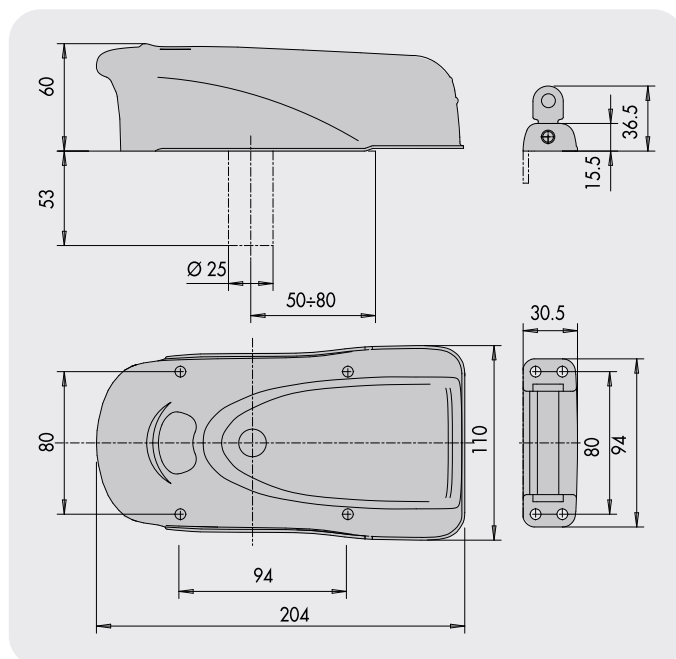

Booster and Booster Plus



BOOSTER MODULE
item 1.07022.00.0

BOOSTER PLUS MODULE

item 1.07022.10.0



The **BOOSTER** module is an electronic circuit which makes it possible for the following functions to be added to the Elettrika series lock:

- **Adapter for operating voltages other than 12 V AC**
Even if the electrical system has a voltage of 12 V DC, 24 V AC, 24 V DC, the BOOSTER allows the lock to function properly.
- **Absorption reduction**
For all those installations where loads with low current absorption are required (e.g. intercom systems with 250 mA absorption).
- **Undersized power supply**
The BOOSTER module ensures sufficient power supply to the lock.
- **Electric hold open function**
By installing a switch in parallel to the lock opening push-button, it is possible to keep the lock powered and thus in an always open state, i.e. "Hold open".

INSTALLATION

The BOOSTER module is installed inside Elettrika as predisposition is foreseen.
It can also be installed in combination with all types of electrically operated rim locks by placing it as close as possible to the lock, as close as possible to the lock.

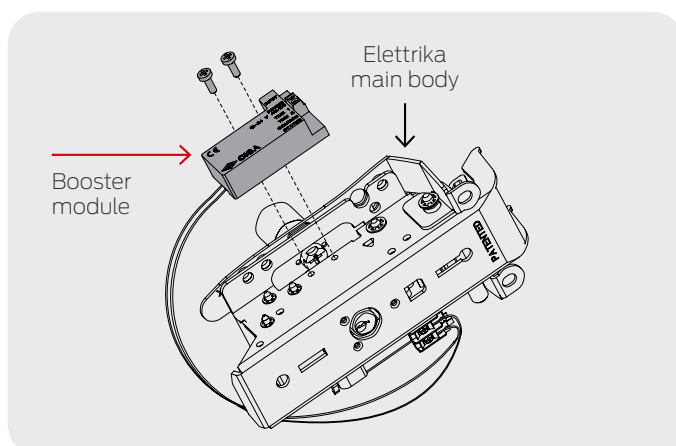

The **BOOSTER PLUS** module has all the functions of the BOOSTER module and combined with a coil with microswitch makes it possible for the following functions to be added to Elettrika:

- **Timing of the opening command**
Possibility of choosing between 5 different opening times for the Elettrika lock. By pressing the electric opening button, the lock remains powered for the set time and the door/gate can be opened. After the time has expired, Elettrika closes automatically.
- **Door status signal**
The BOOSTER PLUS module provides a signal which is activated when the passageway is not securely closed. This signal can be connected to a LED or an alarm system.

INSTALLATION ON ELETTRIKA

The BOOSTER module is installed inside Elettrika as predisposition is foreseen.

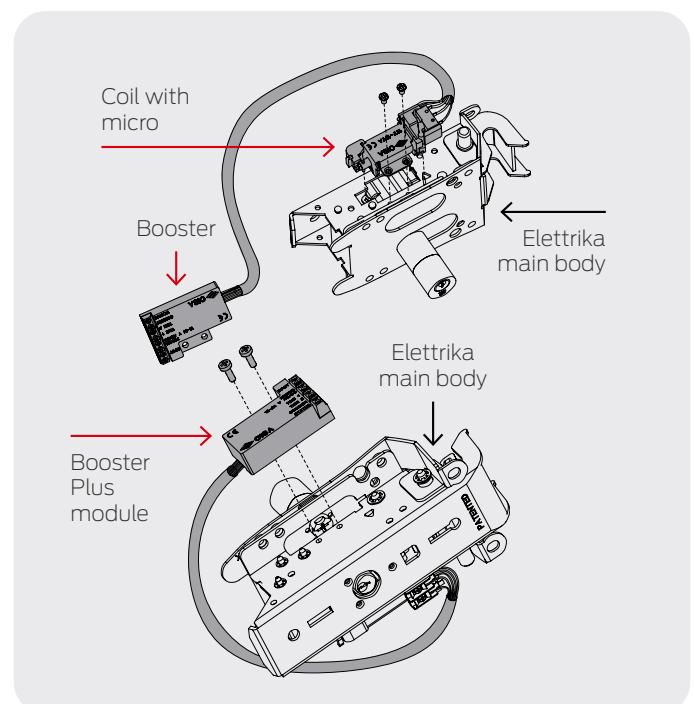

Microswitch and Coil



MICROSWITCH MODULE
item 1.0703..00.0



COIL MODULE
item 1.07025.10.0



The **MICROSWITCH** module provides a contact that can be used to operate the automatic gate directly from Elettrika, thus avoiding the installation of a second lock located on the gate column, generally used to make up for the absence or malfunctioning of the remote control.

OPERATION

- Turning the key either from the inside or the outside releases the lock and then activates the MICROSWITCH, which closes an electrical contact for operating the automatic gate and allows it to be opened directly from the lock.
- The MICROSWITCH module provides a contact that can also be used for other purposes, e.g. it can manage the switching on of lights.

INSTALLATION ON ELETTRIKA

The BOOSTER module is installed inside Elettrika as predisposition is foreseen.

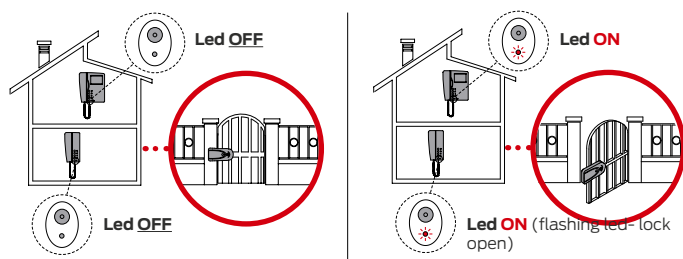
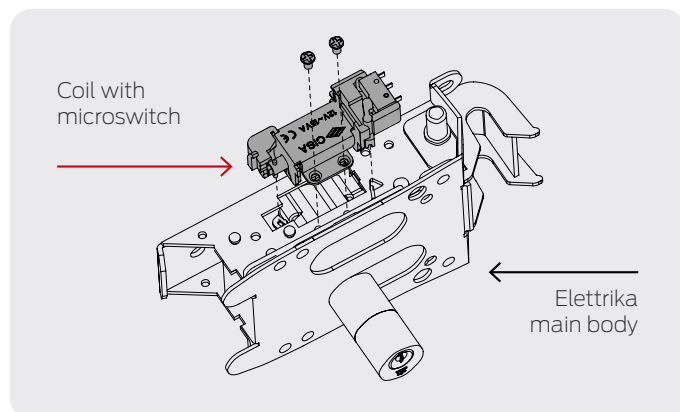

The **COIL** module consists of a coil with microswitch that makes it possible, in combination with the BTicino Swing series doorphones/video doorphones:

- 2-wire digital audio doorphone Swing item 344702-03-04
- 2-wire digital video doorphone Swing item 344802-03-04, to obtain the door status signal of the Elettrika lock (open status).

The COIL module allows the integration of Elettrika also with the BTicino My Home system.

FUNCTIONS

- Door status signal**
The BOBINA module provides a signal which is activated when the passageway is not securely closed. This signal can be connected to an LED.
- Undersized power supply**
The BTicino doorphones/video doorphones of the above-mentioned series have incorporated an electronic circuit which, combined with the COIL module, eliminates all problems of undersized power supply guaranteeing sufficient electrical release power.

INSTALLATION ON ELETTRIKA

The COIL module is installed directly on Elettrika in replacement of the existing coil.

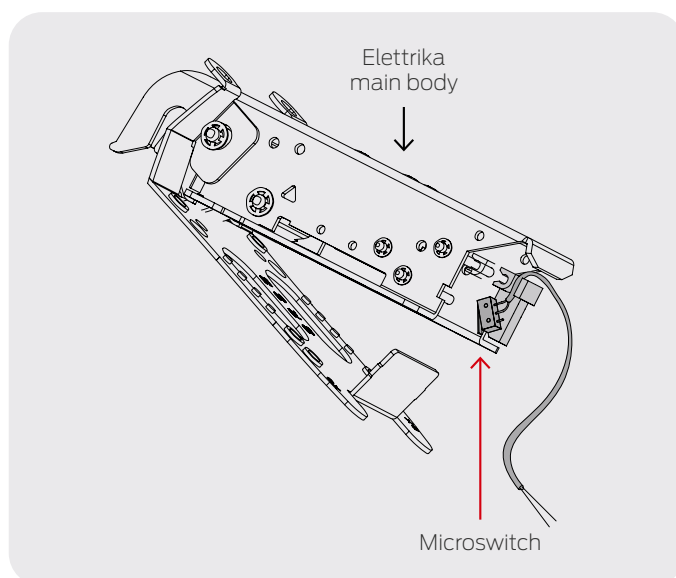

Electric locks series 11000

The renewed CISA range of electrically operated locks is the ideal solution in the residential sector for iron gates and wooden entrance doors, thanks to its easy installation and efficient solutions.

MAIN FEATURES AND BENEFITS:

- Resistance to forced entry.
Certified up to grade 3 Security of the European EN 14846 standard. Protection system against forced entry attempts in the electrical release area.
- Guaranteed opening even in the event of a power failure.
In the event of voltage drops below the minimum threshold (12V), the electrical release control system still guarantees electrical opening of the lock from home (push-button or doorphone).
- Access flow management
The push-button on the lock (present on some models), when locked by the key, allows the door/gate to be always open (hold open function).

 Watch the video



MADE IN
ITALY

Electric locks series 11000

More flexible, more resistant to corrosion

ADJUSTABLE BACKSET

The electric locks leave the factory with a specific backset, but if required the new design allows the backset to be changed from 50 to 80 mm.

HIGH RESISTANCE TO CORROSION

The new coating increases the performance of the lock in the event of outdoor installations or in very corrosive environments (e.g. maritime areas).

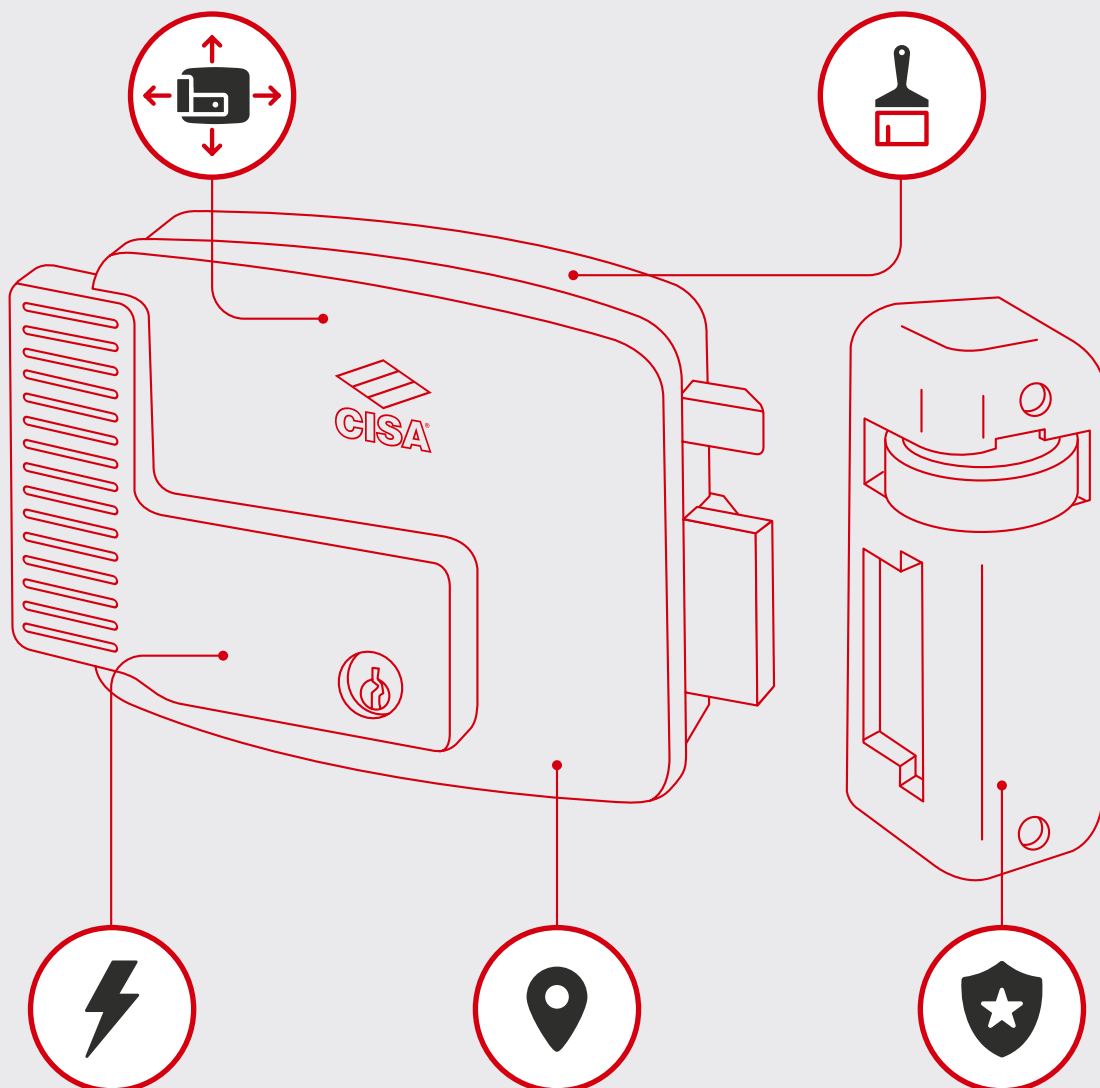

12 V AC

The electric release control system still guarantees that the lock will open even in the event of a power failure.

MADE IN ITALY

Conformity of the product with the highest requirements of the European standards to guarantee Made in Italy excellence.

CERTIFIED PRODUCT

The new electric lock boasts a grade 3 Security of the European standard EN 14846.

Electric locks series 11000

The range



TECHNICAL FEATURES

- Grey lacquered steel case and striker (fin. N7)
- Dead-locking latch in chrome-plated aluminium
- Nickel-plated external tubular cylinder length 55mm
- Voltage 12V AC
- Absorbed current: 2.5A

OPERATION

- From outside with the key
- From inside with a push-button or a key plus electric control

SUPPLIED AS STANDARD

- Striker
- Instructions sheet
- Fixing screws
- 3 keys item 1.01070.10.1

HAND

- Hand 1 Right hand inwards
- Hand 2 Left hand inwards
- Hand 3 Right hand outwards
- Hand 4 Left hand outwards

FINISH

- Grey epoxy powder coating

STANDARDS

- This series of electric locks is certified to the European standard EN 14846:08;3|C|2|0|0|M|3|0|2| Grade 3 Security (500 kg lateral thrust and 200 kg frontal thrust)

ACCESSORIES AVAILABLE ON REQUEST

- Booster module item 1.07022.000

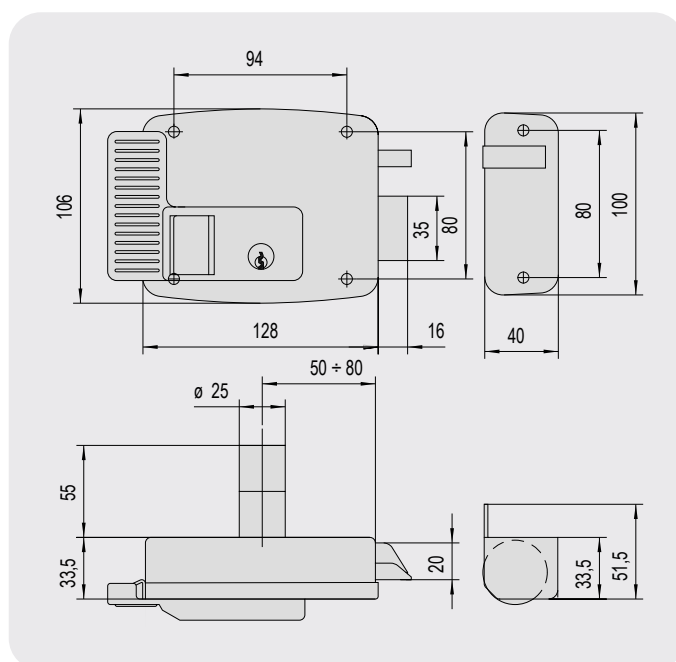



CISA Gate closer

The CISA gate closer that can be installed on pedestrian gates allows the gate to close automatically after people have passed through.

MAIN FEATURES AND BENEFITS:

- Security of always keeping the gate closed after each passage thanks to automatic closing.
- Operation in all weather conditions thanks to fluid-free mechanism.
- Flexibility and easy adjustment for pedestrian gates up to 55 kg



MADE IN
ITALY

CISA Gate closer

Gate closed after each passage.

AUTOMATIC CLOSING

The gate will close automatically after each opening by means of a spring mechanism with adjustable intensity.

CONSTANT OPERATION THAT LASTS

Installed outdoors, it guarantees constant operation over time. The fluid-free gate closer is unaffected by temperature fluctuations that can alter its performance.

CAN BE INSTALLED ON GATES OF DIFFERENT WEIGHTS AND SIZES

The speed and closing intensity adjustment system allows it to be installed on gates of different sizes and weights (up to 1,200 mm for 55 kg max. weight).

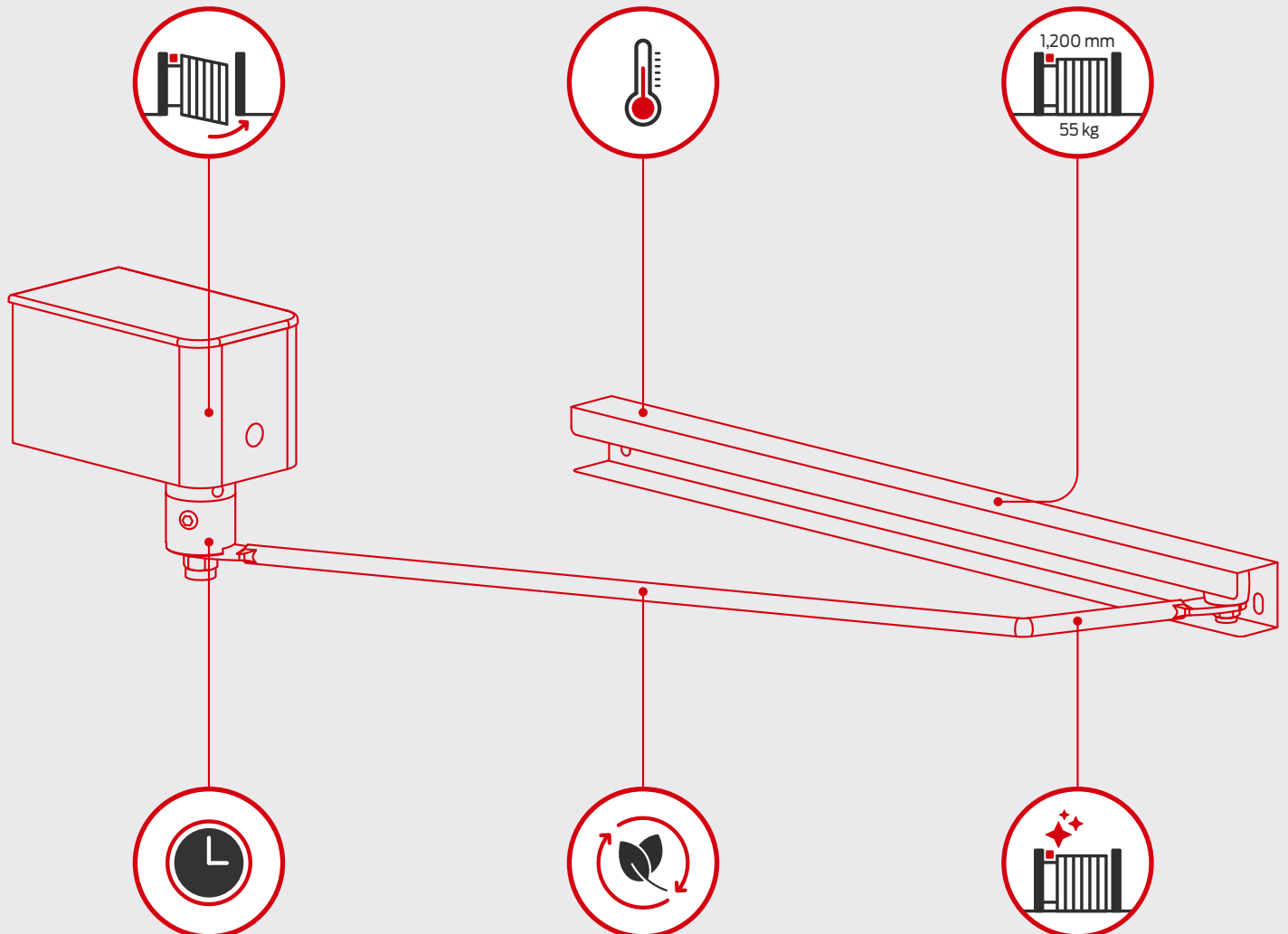

LONG LIFE

The special anti-corrosion treatment and stainless steel regulators have been specifically designed for outdoor application, enabling excellent durability.

SUSTAINABILITY

Being fluid-free, the gate closer is an environmentally friendly product because it does not involve the disposal of oil.

RESPECT FOR DESIGN

The sliding arm system allows the gate closer to be installed on the gate column or adjacent wall without compromising the aesthetics of the gate itself.

CISA Gate closer



TECHNICAL FEATURES

- Pressure die-cast aluminium case and cover, painted and with anti-corrosion treatment (resists more than 500 hours in salt spray)
- Stainless steel adjusters
- Zinc-plated fixing screws
- Zinc-plated steel springs
- Zinc-plated steel arm and guide
- Tested for 200,000 opening and closing cycles

SUPPLIED AS STANDARD

- Zinc-plated adjustable angle mounting plate
- Sliding arm with guide
- Fixing screws
- Instructions sheet

FINISHES

- Mica black
- Silver grey







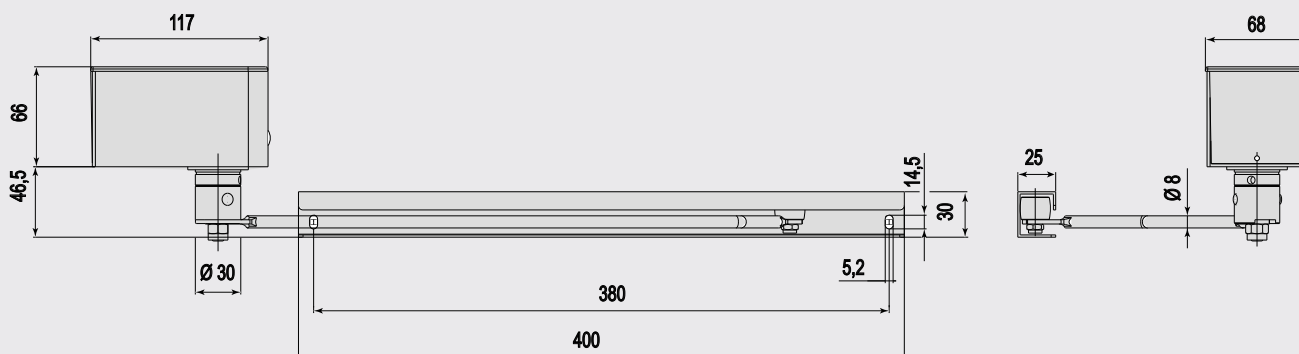

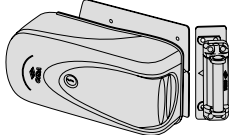

OPERATION

- For use on gates up to 1,200 mm and weighing a maximum of 55 kg
- The gate closer is supplied for right handed (1) or left handed (2) use, please select the appropriate item for your application
- Completely mechanical operation with no fluids (operates irrespective of outdoor temperature).
- Adjustable opening / closing force
- Hold open facility possible between 90° and 100°
- Maximum gate wing opening 100°

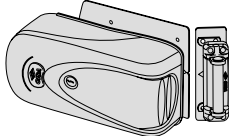
PATENTED SYSTEM A000790 OF 2013



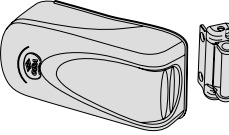
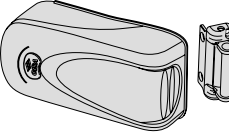

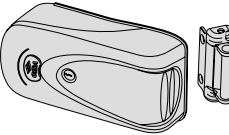





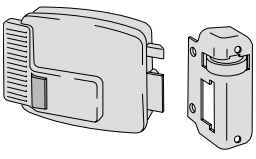
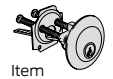

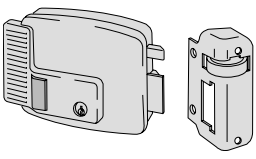
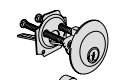
TYPE	DESCRIPTION	CYLINDER	BACKSET	kg		ITEM						
				UNIT WEIGHT	NO. PCS	TYPE	DIM.	HAND	FIN.	PEPS.		
	VERSION FOR STEEL DOORS/GATES ▪ Back plate and spacer, to be welded		50÷80	2.800	1	1	1A721	00	0			
	Finish 79 - zinc-plating		50÷80	2.800	1	1	1A721	00	0	79		
	Bticino coil		50÷80	2.800	1	1	1A721	00	0	00	PA	
	Booster		50÷80	2.800	1	1	1A721	00	0	00	PB	
	Booster Plus		50÷80	2.800	1	1	1A721	00	0	00	PC	
	VERSION FOR STEEL DOORS/GATES ▪ Back plate for lock and striker, to be welded ▪ Inside push-button ▪ Hold-open device		50÷80	2.800	1	1	1A731	00	0			
	Finish 79 - zinc-plating		50÷80	2.800	1	1	1A731	00	0	79		
	Bticino coil		50÷80	2.800	1	1	1A731	00	0	00	PA	
	Booster		50÷80	2.800	1	1	1A731	00	0	00	PB	
	Booster Plus		50÷80	2.800	1	1	1A731	00	0	00	PC	
	VERSION FOR STEEL DOORS/GATES ▪ Inside push-button		50÷80	2.800	1	1	1A611	00	0	00	DF	
	VERSION FOR WOODEN DOORS ▪ Inside push-button		50÷80	2.350	1	1	1A610	00	0			
	Booster Plus		50÷80	2.350	1	1	1A610	00	0	00	PC	
	VERSION FOR WOODEN DOORS ▪ Inside push-button ▪ Brass escutcheon		50÷80	2.350	1	1	1A611	00	0			
	Booster Plus		50÷80	2.350	1	1	1A611	00	0	00	PC	
	VERSION FOR WOODEN DOORS ▪ Inside push-button ▪ Hold-open device		50÷80	2.800	1	1	1A630	00	0			
	VERSION FOR WOODEN DOORS ▪ Inside push-button ▪ Hold open ▪ Brass escutcheon		50÷80	2.800	1	1	1A631	00	0			

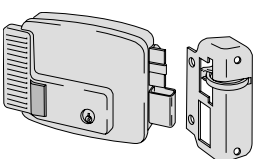

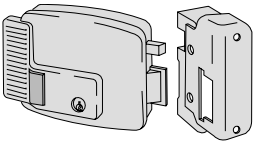

TYPE	DESCRIPTION	CYLINDER	THROWS	BACKSET	kg		ITEM		TYPE	DIM.	HAND	FIN.	PEPS.			
					UNIT WEIGHT	NO. PCS										
<ul style="list-style-type: none"> Protective back plate and spacer 		 Item 102139 00 0 12	50	2.140	5	1	11721	50	1	N7						
			50	2.140	5	1	11721	50	2	N7						
			60	2.140	5	1	11721	60	1	N7						
			60	2.140	5	1	11721	60	2	N7						
			70	2.140	5	1	11721	70	1	N7						
			70	2.140	5	1	11721	70	2	N7						
			80	2.140	5	1	11721	80	1	N7						
			80	2.140	5	1	11721	80	2	N7						
<ul style="list-style-type: none"> Protective back plate and spacer Inside push-button and cylinder Hold-open device 		 Item 102110 00 0 12	50	2.180	5	1	11731	50	1	N7						
			50	2.180	5	1	11731	50	2	N7						
			60	2.180	5	1	11731	60	1	N7						
			60	2.180	5	1	11731	60	2	N7						
			70	2.180	5	1	11731	70	1	N7						
			70	2.180	5	1	11731	70	2	N7						
			80	2.180	5	1	11731	80	1	N7						
			80	2.180	5	1	11731	80	2	N7						
<ul style="list-style-type: none"> Protective back plate and spacer Manual throw deadbolt 		 Item 102145 00 0 12	2	50	2.200	1	1	11761	50	1	N7					
			2	50	2.200	1	1	11761	50	2	N7					
			2	60	2.200	1	1	11761	60	1	N7					
			2	60	2.200	1	1	11761	60	2	N7					
			2	70	2.200	1	1	11761	70	1	N7					
			2	70	2.200	1	1	11761	70	2	N7					
			2	50	2.230	1	1	11771	50	1	N7					
			2	50	2.230	1	1	11771	50	2	N7					
<ul style="list-style-type: none"> Protective back plate and spacer Inside push-button and cylinder Manual throw deadbolt 		 Item 102145 00 0 12	2	60	2.230	1	1	11771	60	1	N7					
			2	60	2.230	1	1	11771	60	2	N7					
			2	70	2.230	1	1	11771	70	1	N7					
			2	70	2.230	1	1	11771	70	2	N7					
			<ul style="list-style-type: none"> Outward opening 		 Item 102139 00 0 12	50	1.450	1	1	11921	50	3	N7			
						50	1.450	1	1	11921	50	4	N7			
						60	1.450	1	1	11921	60	3	N7			
						60	1.450	1	1	11921	60	4	N7			
70	1.450	1				1	11921	70	3	N7						
70	1.450	1				1	11921	70	4	N7						
80	1.450	1				1	11921	80	3	N7						
80	1.450	1				1	11921	80	4	N7						
<ul style="list-style-type: none"> Outward opening Inside push-button and cylinder Hold-open device 		 Item 102142 00 0 12	50	1.470	1	1	11931	50	3	N7						
			50	1.470	1	1	11931	50	4	N7						
			60	1.470	1	1	11931	60	3	N7						
			60	1.470	1	1	11931	60	4	N7						
			70	1.470	1	1	11931	70	3	N7						
			70	1.470	1	1	11931	70	4	N7						
			80	1.470	1	1	11931	80	3	N7						
			80	1.470	1	1	11931	80	4	N7						
<ul style="list-style-type: none"> For automated and up-and-over gates Protective back plate External cylinder length: 70 mm 			80	2.100	1	1	11823	80	1	N7						
			80	2.100	1	1	11823	80	2	N7						

TYPE	DESCRIPTION	CYLINDER	THROWS	BACKSET	kg		ITEM							
					UNIT WEIGHT	NO. PCS	TYPE	DIM.	HAND	FIN.	PEPS.			
<ul style="list-style-type: none"> Inside push-button 		 Item 10G500 00 0 12	50	1.150	1	1	11610	50	1	N7				
			50	1.150	1	1	11610	50	2	N7				
			60	1.150	1	1	11610	60	1	N7				
			60	1.150	1	1	11610	60	2	N7				
			70	1.150	1	1	11610	70	1	N7				
			70	1.150	1	1	11610	70	2	N7				
			80	1.150	1	1	11610	80	1	N7				
			80	1.150	1	1	11610	80	2	N7				
		 Item 10G200 55 0 12	50	1.440	1	1	11611	50	1	N7				
			50	1.440	1	1	11611	50	2	N7				
			60	1.440	1	1	11611	60	1	N7				
			60	1.440	1	1	11611	60	2	N7				
			70	1.440	1	1	11611	70	1	N7				
			70	1.440	1	1	11611	70	2	N7				
			80	1.440	1	1	11611	80	1	N7				
			80	1.440	1	1	11611	80	2	N7				
<ul style="list-style-type: none"> Inside push-button and cylinder Hold-open device 		 Item 102104 00 0 12	50	1.530	1	1	11630	50	1	N7				
			50	1.530	1	1	11630	50	2	N7				
			60	1.530	1	1	11630	60	1	N7				
			60	1.530	1	1	11630	60	2	N7				
			70	1.530	1	1	11630	70	1	N7				
			70	1.530	1	1	11630	70	2	N7				
			80	1.530	1	1	11630	80	1	N7				
			80	1.530	1	1	11630	80	2	N7				
		 Item 102110 00 0 12	50	1.530	1	1	11631	50	1	N7				
			50	1.530	1	1	11631	50	2	N7				
			60	1.530	1	1	11631	60	1	N7				
			60	1.530	1	1	11631	60	2	N7				
			70	1.530	1	1	11631	70	1	N7				
			70	1.530	1	1	11631	70	2	N7				
			<ul style="list-style-type: none"> Inside push-button and cylinder Two-throw deadbolt 		 Item 102146 00 0 12	2	50	1.650	1	1	11670	50	1	N7
						2	50	1.650	1	1	11670	50	2	N7
2	60	1.650				1	1	11670	60	1	N7			
2	60	1.650				1	1	11670	60	2	N7			
2	70	1.650				1	1	11670	70	1	N7			
2	70	1.650				1	1	11670	70	2	N7			
 Item 102145 00 0 12	2	70			1.750	1	1	11671	70	1	N7			
	2	70			1.750	1	1	11671	70	2	N7			

TYPE	DESCRIPTION	CYLINDER	THROWS	BACKSET	kg		ITEM				
					UNIT WEIGHT	NO. PCS	TYPE	DIM.	HAND	FIN.	PEPS.
 <ul style="list-style-type: none"> Outward opening Inside push-button and cylinder Hold-open device 					1.530	1	1	11630	50	3	N7
								11630	50	4	N7
								11630	60	3	N7
								11630	60	4	N7
								11630	70	3	N7
								11630	70	4	N7
								11630	80	3	N7
								11630	80	4	N7
								07018	00	1	N7
								07018	00	2	N7
  <ul style="list-style-type: none"> Gray lacquered steel striker with roller For locks series 11610, 11611, 11630, 11631 11721, 11731, 11921, 11931 											

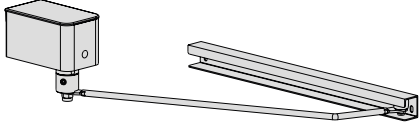
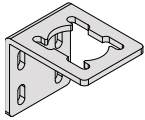
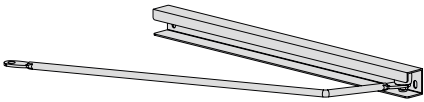

TYPE	DESCRIPTION	kg		ITEM				
		UNIT WEIGHT	NO. PCS	TYPE	DIM.	HAND	FIN.	
	<ul style="list-style-type: none"> BLACK gate closer with sliding arm 	2.500	1	1	C1310	11	1	
		2.500	1	1	C1310	11	2	
	<ul style="list-style-type: none"> GREY gate closer with sliding arm 	2.500	1	1	C1310	11	1	97
		2.500	1	1	C1310	11	2	97
	<ul style="list-style-type: none"> Corner plate (supplied as standard) 	0.450	1	1	07155	01	0	
	<ul style="list-style-type: none"> Sliding arm 	0.500	1	1	07155	06	0	
	<ul style="list-style-type: none"> Kit of spare springs 	0.500	1	1	07156	03	0	





About Allegion

At Allegion (NYSE: ALLE), we design and manufacture innovative security and access solutions that help keep people safe where they live, learn, work and connect. We're pioneering safety with our strong legacy of brands like CISA®, Interflex®, LCN®, Schlage®, SimonsVoss®, Von Duprin® and [insert your local brand(s) here]. Our comprehensive portfolio of hardware, software and electronic solutions is sold around the world and spans residential and commercial locks, door closer and exit devices, steel doors and frames, access control and workforce productivity systems.





For more, visit allegion.com.



 CISA SpA
Via Oberdan 42
48018 Faenza (RA) Italy

 Ph. +39 0546 677111
Fax +39 0546 677150

 Customer Service and Technical Support
+39 0546 188 0070

    cisa.com
cisa.sales@allegion.com